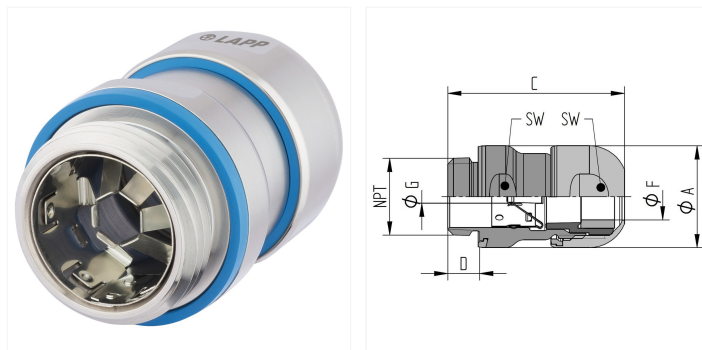

SKINTOP® HYGIENIC SC NPT 1/4IN
Article No.: 54114300

Cable gland; NPT 1/4"; Clamping range (min./max.): 0.157 - 0.236 in; Wrench width 1: 0.63; Stainless steel Uncoated; UV-resistant; IP 68 - 10 g/cm² (30 min), IP 69; EMC shielding

Details
Benefits

- Hygienic design with smooth surfaces and contours without corners and edges prevents residues such as liquids and micro-organisms from accumulating and posing a risk of contamination for food processing machinery. This facilitates simple, frequent and safe product cleaning.
- Multiple food and beverage certifications for Europe and North America.
- Tested resistance to ECOLAB® disinfectants and cleaning agents.
- The best possible sealing enables protection classes IP 68 (10 bar) and IP 69.
- Optimum EMC protection thanks to integrated, highly conductive and flexible contact spring, which creates a low-resistance transition between the copper braided shielding and the gland.
- Sealing material in blue to easily distinguish the cable glands used in the food industry.
- Sealing material compliant with FDA 21 CFR 177.2600, specifically for the food and beverage industry in North America.
- Certified according to NSF/ANSI 169 for use in hygiene-critical areas in North America (Standard: Special Purpose Food Equipment and Devices/for Use in Food Zone Non Contact).

- Certified according to EHEDG for use in hygienic areas in Europe (certification type EL, certification class I AUX) while observing the hygienic design principles (guideline "Design criteria for hygienic machinery, appliances and components").

Application

- For EMC-compliant insertion of copper-shielded cables.
- Especially for hygiene-critical areas of the food industry, where the product needs to be installed in the product zone or in the direct food production environment.
- Also suitable for use in hygiene-critical areas of the pharmaceutical and chemical industry.
- Withstands high chemical and mechanical loads.

Notes

Photographs and graphics are not to scale and do not represent detailed images of the respective products.

If applicable, the prices are solid metal prices without additional charges and VAT. Sales only to business customers.

Unless specified otherwise, the product values shown are rated values at room temperature. You can receive additional values, such as tolerances, upon request if they are available and have been released for publication.

Remarks

Technical Data

General information

Brand	SKINTOP®
Product type	Cable gland
Delivery with lock nut	No
Type of packaging	Bag
Delivery Unit	5

Electrical parameters

Product design

For armored cables	No
Glass-fibre reinforced	No

Number of cable entries	1 pc.
With bending protection	No
Cable gland design	Straight
Total length	1.555 in
Clear width	0.236 in
Thread type	NPT
Thread size	NPT 1/4"
Pitch of thread	1,41
Thread length	0.283 in
Spanner size 1	0.63 in
Wrench size 2	0.63 in
Hexagon corner dimensions	0.74 in
Clamping range min.	0.157 in
Clamping range max.	0.236 in
EMC shielding	Yes
Material insert	Polyamide
Seal type	Conduit Sealing Ring
Thread-side sealing element	Flat seal
Cable-side sealing element	Conduit Sealing Ring
Material sealing	Fluorinated rubber
Body material	Stainless steel
Body material, short form	V4A
Surface protection	Uncoated
Colour description	metal

Product features

IP protection rating	IP 68 - 10 g/cm ² (30 min) IP 69
NEMA classification type	Type 1 Type 2 Type 4x Type 6 Type 12
Suitable for EX-applications	No
Temperature (min.)	-20 °C

Max. temperatur	100 °C
Flame-retardant	Yes
UV-resistant	Yes
Chemical resistant	Yes
Acid-resistant	Yes
corrosion resistant	Yes
Halogenfree	No
Oil resistant	Yes
Impact proof	Yes
Vibration protection	Yes
Strain relief	Yes

Certifications and standards

CE marking	Yes
UL recognized	Yes
UL AWM certification	according to UL 514B (CCN: QBPZ2 / e-file number: E79903)
UL listed	No
cUR recognized	Yes
cUR certification	according to CSA C22.2 No. 18.3 (CCN: QBPZ8 / e-file number: E79903)
cUL listed	No
CSA certified	No
VDE certified	No
For Ex zone gas	without
For Ex-zone dust	without
GGVS certified	No
DNV-certified	No
Tested for fire protection for railway vehicles	No
Ecolab certified	Yes
NSF certified	Yes
FDA certified	Yes

FDA certification according to	CFR 21
EHEDG certified	Yes

SKINTOP® HYGIENIC SC NPT

Article No.	Name	Thread size	Thread length	Clamping range min.	Clamping range max.	Spanner size 1	Delivery Unit
54114300	SKINTOP® HYGIENIC SC NPT 1/4IN	NPT 1/4"	0.283 in	0.157 in	0.236 in	0.63 in	5
54114310	SKINTOP® HYGIENIC SC NPT 3/8IN	NPT 3/8"	0.307 in	0.256 in	0.354 in	0.787 in	5
54114320	SKINTOP® HYGIENIC SC NPT 1/2IN	NPT 1/2"	0.331 in	0.354 in	0.472 in	0.945 in	5
54114330	SKINTOP® HYGIENIC SC NPT 3/4IN	NPT 3/4"	0.346 in	0.453 in	0.61 in	1.142 in	5

V1.1